

elementy wg. normy DIN

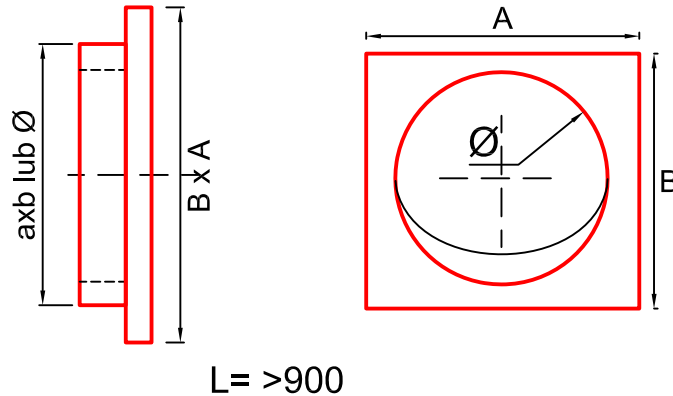

3 / ZAS

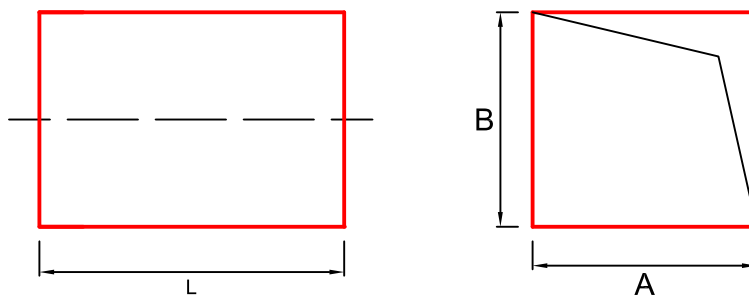

10 / K

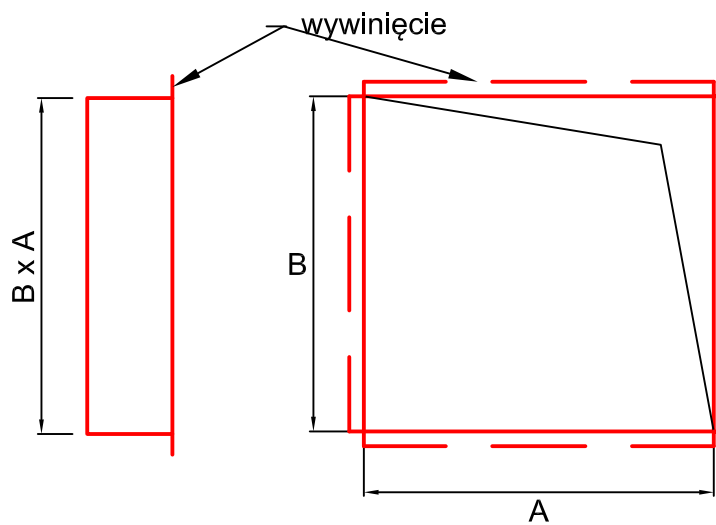

11 / ST

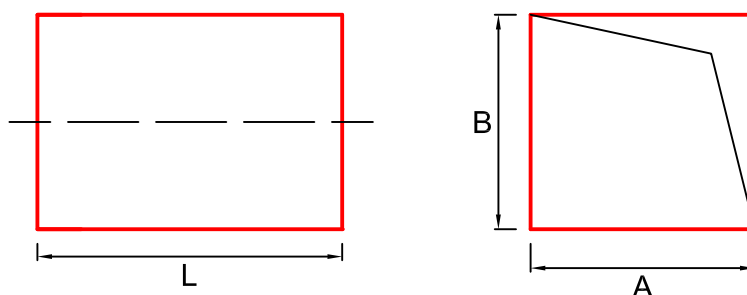

12 / KT

elementy wg. normy DIN

L = <901

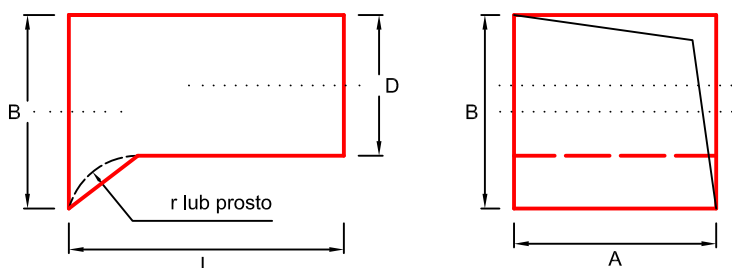

15 / SU

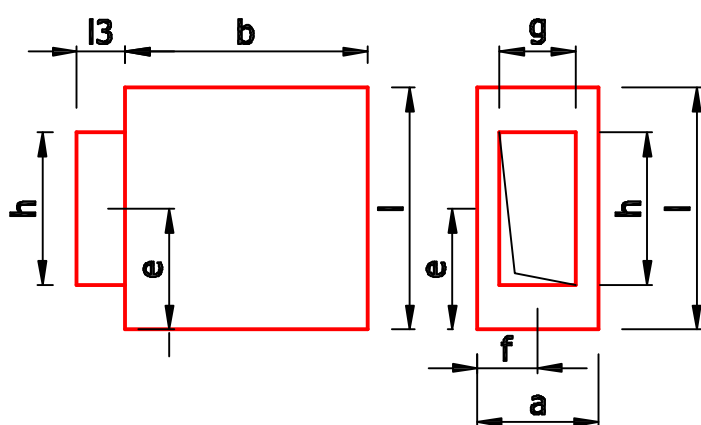

trójkąt - czwórnik
18 / KMA*

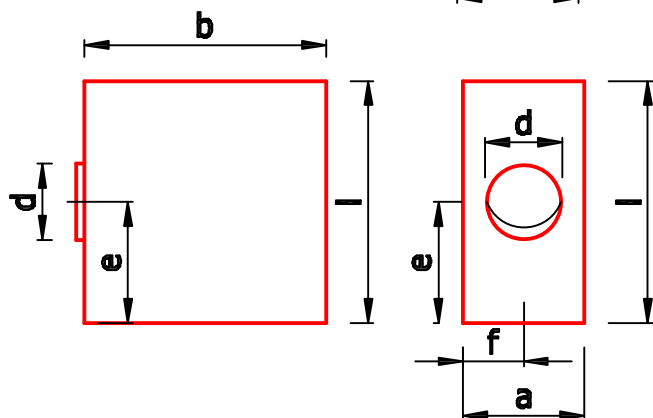

trójkąt - czwórnik
18 / KMA*

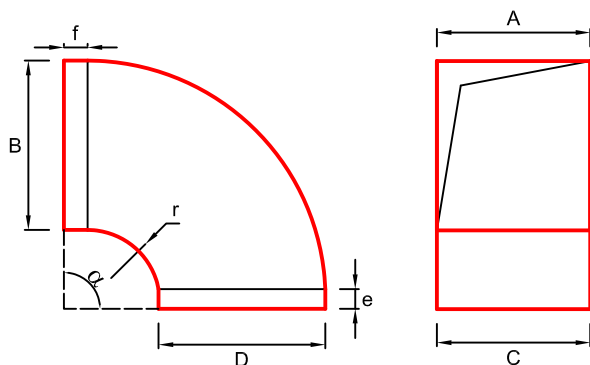

20 / BS

elementy wg. normy DIN

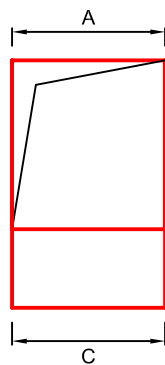
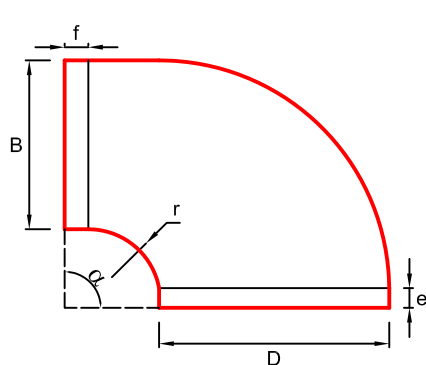

21 / BA

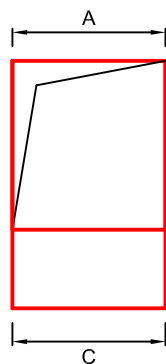
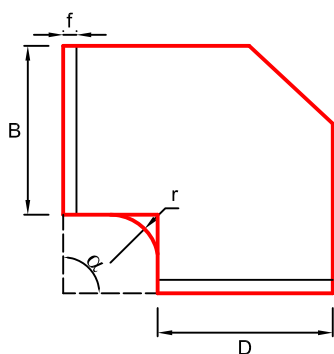

23 / BBR

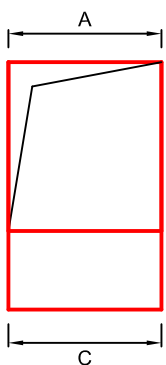
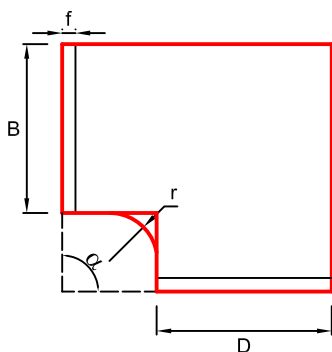

30 / WS

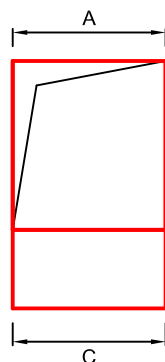
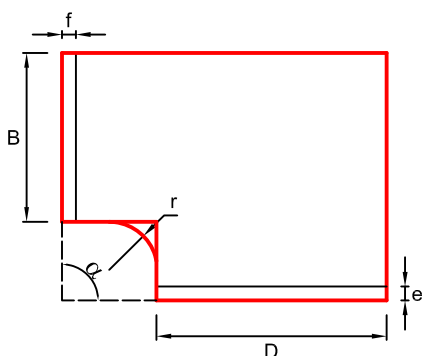

31 / WA

elementy wg. normy DIN

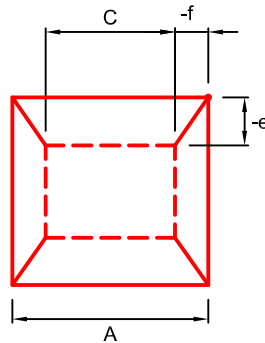
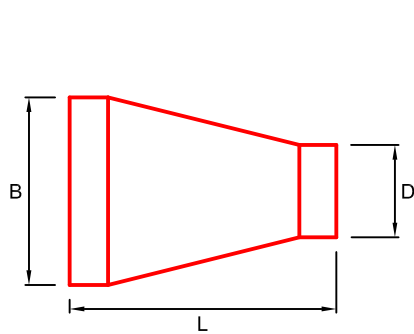

40 / US

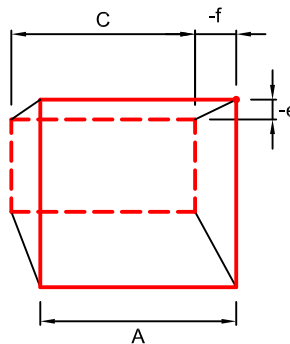
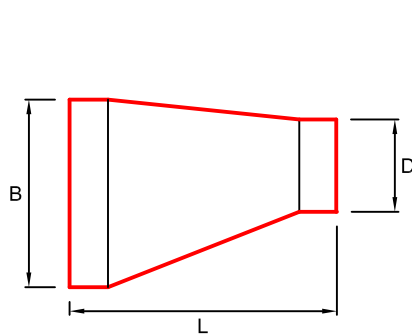

41 / UA

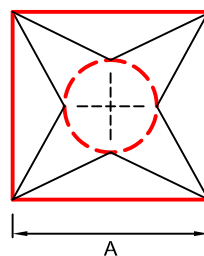
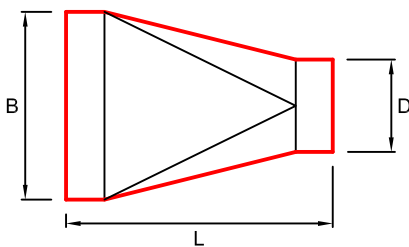

50 / RS

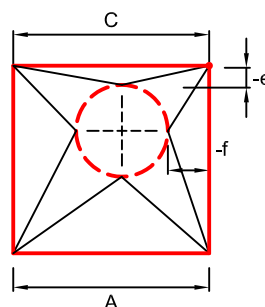
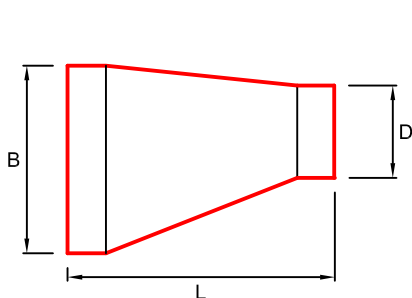

51 / RA

elementy wg. normy DIN

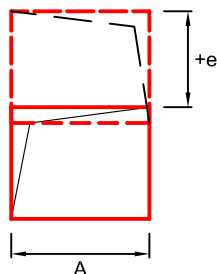
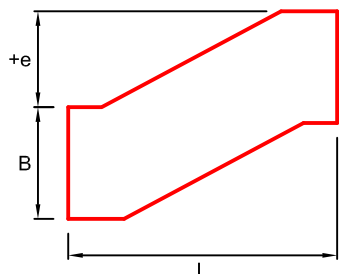

60 / ES

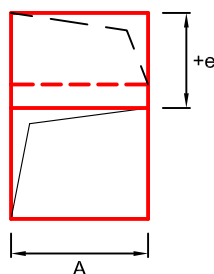
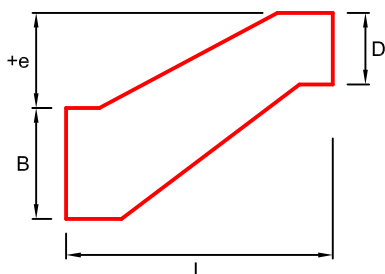

61 / EA

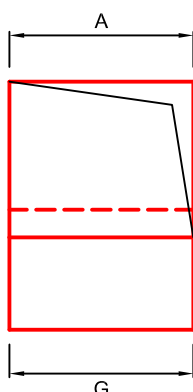
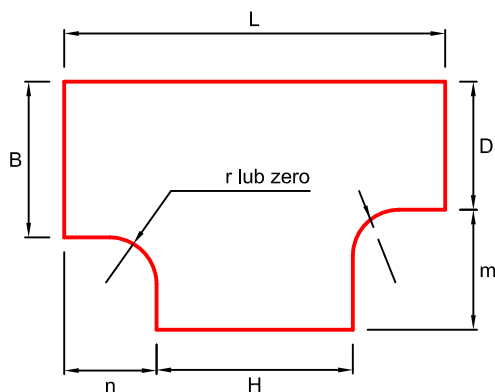

70 / TS

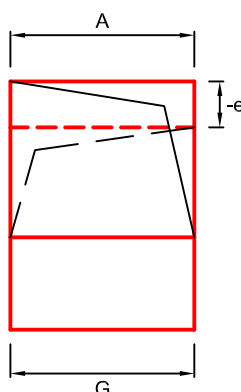
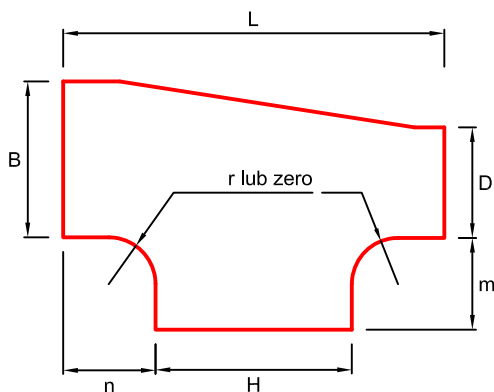

71 / TA

elementy wg. normy DIN

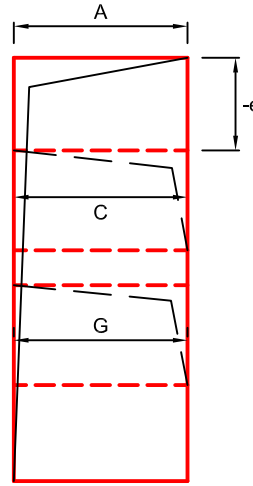
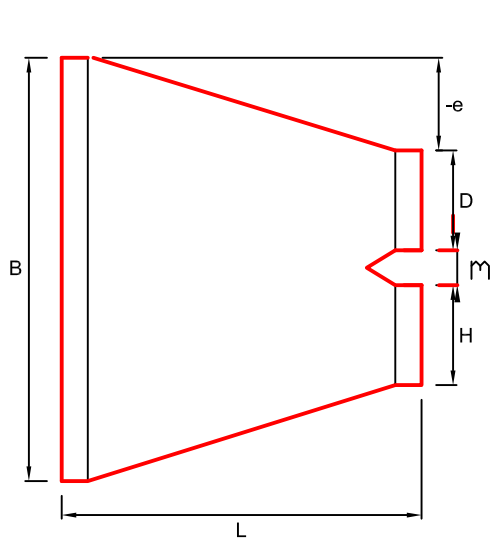

80 / HS

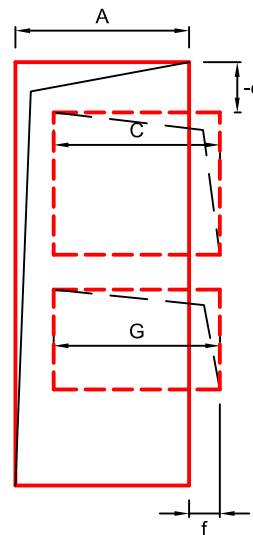
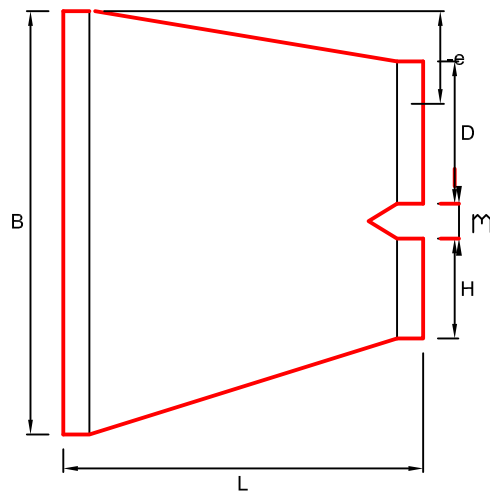

81 / HA

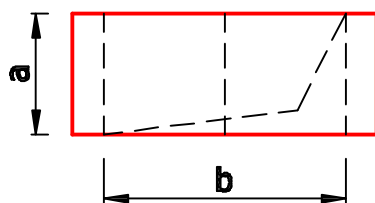
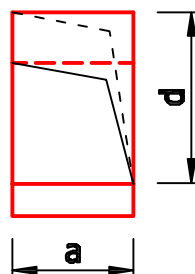
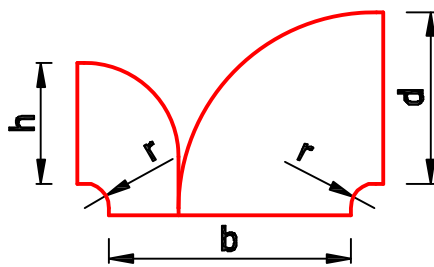

"combi"
Dwa elementy lub
więcej na wspólnej
ramce